



**Marine Specialised Technology Group**







Marine Specialised Technology (MST) is the world's leading provider of Rigid Inflatable and High Speed Workboats for military and professional use. We offer flexible modular solutions tailored to meet our customer's specific requirements from a range of well proven platforms.

Through world class innovation, program execution and customer understanding we aim to provide superior craft for enhanced operational and performance effectiveness with the assurance of long term reliability and after sales support.

MST is a customer focused organisation with a worldwide performance culture. MST works with demanding customers in the global defence, law enforcement and search & rescue markets.

**“  
World Class through design,  
technology & dedication**

---

# A PROFESSIONAL APPROACH

MST's business model is unique in the industry and concentrates on the development, design and final assembly of their craft with major components subcontracted under the close supervision of MST's experienced project and technical management teams.

This allows the company to concentrate on "what it does best" and benefit from the vast range of specialised skills offered by other companies "doing what they do best", including advanced composite moulders using exotic fibre reinforced plastic materials to aerospace grade fabricators working with stainless, titanium and aluminium.

MST works closely with the client during a project to ensure that they are actively involved in the production of their craft, recognising the importance of thoroughly understanding how and where the craft will be operated and for what purpose.

***MST successfully operates quality assurance systems accredited to ISO9001:2008 and compliant with AQAP2110***

***MST has physical security infrastructures and security management systems in place***

***MST's environmental systems are accredited to ISO14001***

---



# WORKING WITH TECHNOLOGY

MST utilises state of the art Solidworks™ 3-dimensional computer aided engineering software to develop its craft and components.

Every aspect of each craft is fully modelled including material properties allowing MST to calculate extremely accurate weight predictions and successfully engineer complex lifting systems for precise dynamic behaviour. Concepts can be rapidly produced for evaluation purposes allowing clients to accurately visualise their proposed craft and be actively involved in the vessels development.

MST's team of naval architects are experienced in a wide range of disciplines, from hull design through to prototype testing and classification society compliance.

MST carry out finite element analysis of structures in-house to ensure such features as lift systems or towing arrangements are safe for their intended purpose. In addition, structures are optimised as part of weight saving disciplines and as part of a company wide efficient engineering ethos, with all design work controlled through our accredited QA system.

In house electrical engineering design and development keeps MST at the forefront of electrical systems engineering for commercial RIB's and workboats, focusing on system reliability and maintainability, adhering to relevant international standards at all times.

- **Composite (fibre reinforced plastic)**
- **Aluminium**
- **Combination construction**
- **Advanced composite**

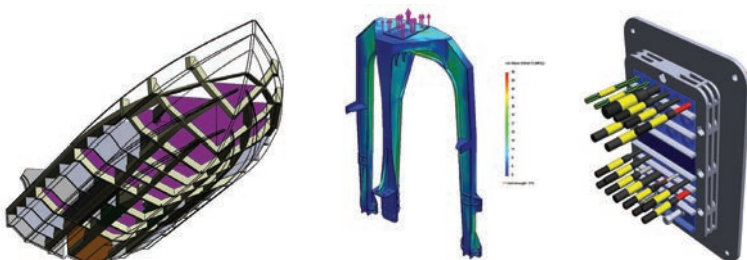

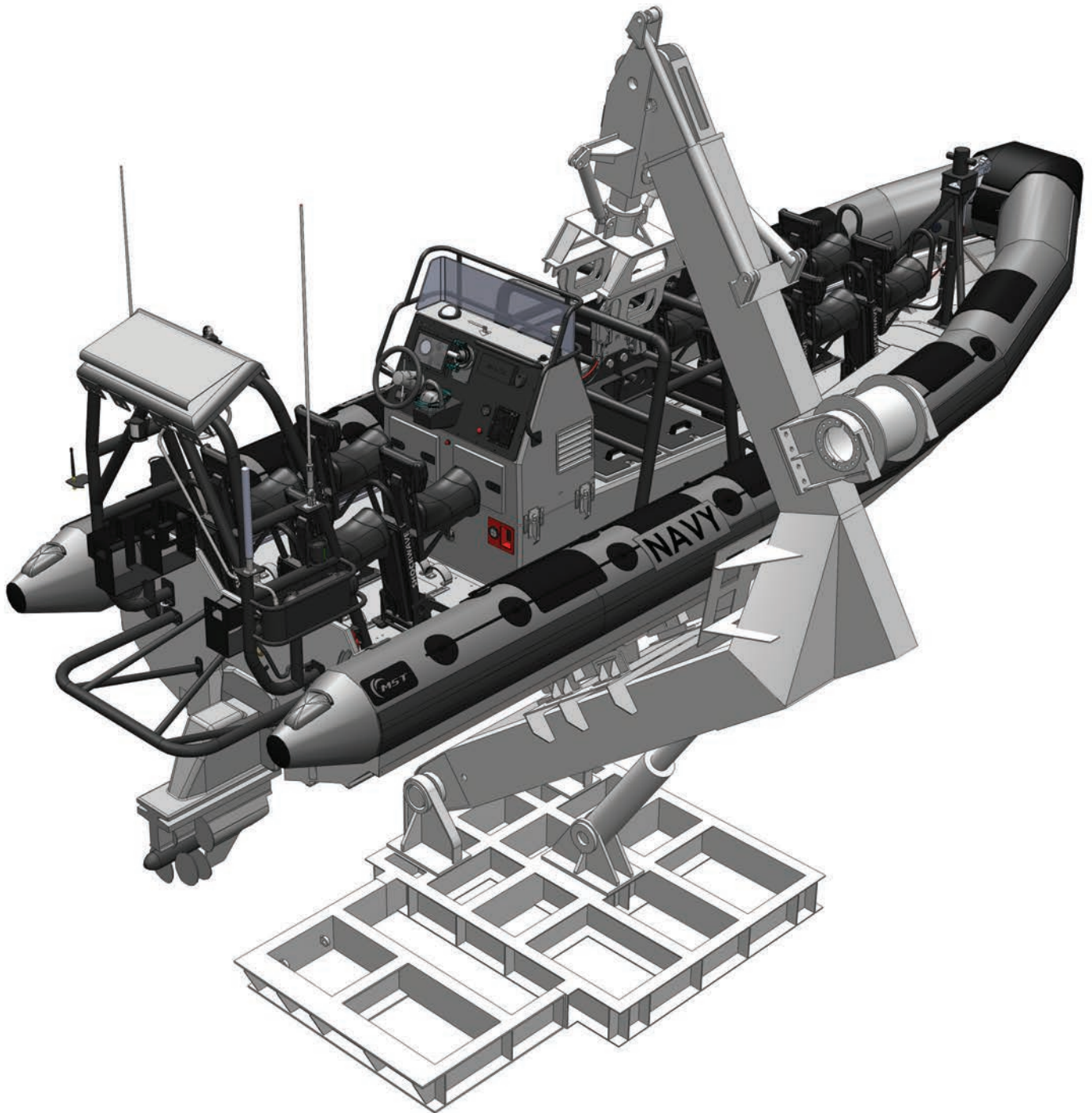

“  
**State of the art Solidworks™  
3-dimensional computer aided  
engineering software**

---

# MANAGING YOUR PROJECT

MST work closely with the customer to fully understand their specific needs and translate these into a successful craft with maximum performance, capability and effectiveness. You are then provided with a dedicated Project Manager offering clear single point communication for the entire contract.

For shipyards we specialise in vessel launched craft including single, twin and four-point lift and stern ramp launched applications and will work closely with the yard to ensure overall project success. Our wealth of knowledge drawn from over a decade of experience can provide the competitive edge for a yard delivering state of the art offshore patrol vessels, on which our craft are essential components of the vessels armament.

Our focus on customer service is second to none. After delivery our own dedicated after sales, service and support division, MST Fleet Services, steps in and provides you and your customers with seamless support for the entire life of the craft.

For projects requiring in-country content we can work with strategic partners through technology transfers and provide the necessary training, project oversight and support necessary for success.

- **Dedicated Project Managers & Teams**
- **Dedicated After Sales, Service & Support Division**
- **Technology Transfers**

“

***Rest assured you are being supported by one of the most experienced suppliers of commercial and military craft in the world***

---



# PRODUCT RANGE

---

## SR

480



620



750



900

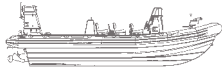

---

## PATROL

650

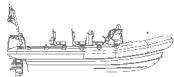

680

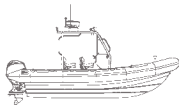

750

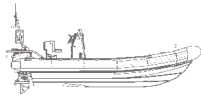

900



---

## SEABOAT

500

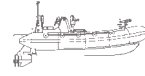

650

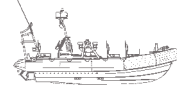

750



800



900



---

## FRISC

950



1200

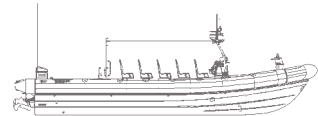

WH

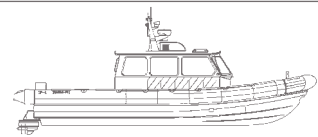

---

## SUBMERSIBLE

680



1100

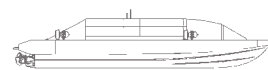

**TASKFORCE**

550



800

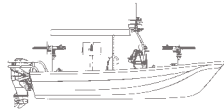

**INTERCEPTOR**

T1100-OB



T1100-IB

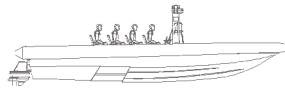

T1100-OB



T1100-IB



**WHEELHOUSE**

890 SAR

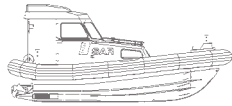

1050 HPB

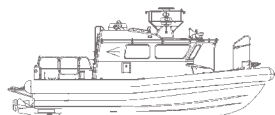

1300 HPB

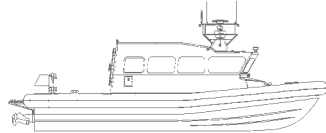

1350 WAC

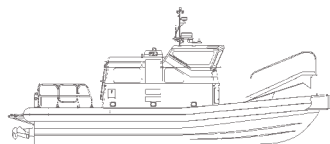

1500 PATROL

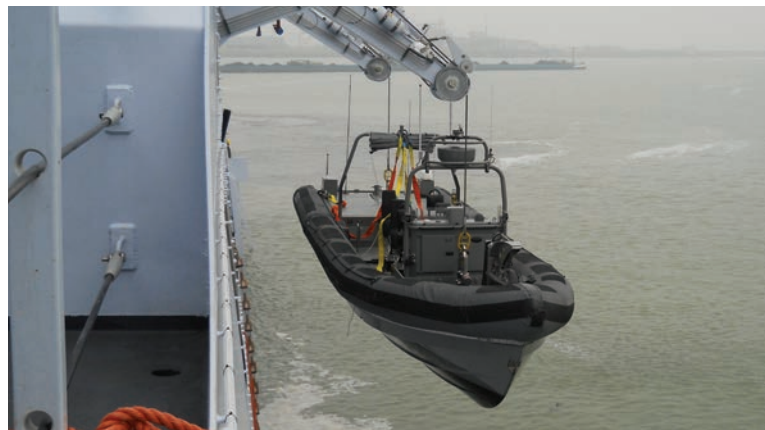
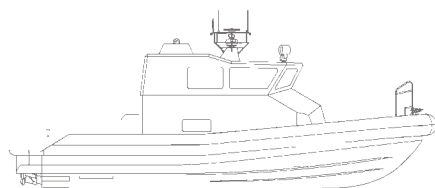

# APPLICATIONS

- Border Control
- Naval
- Paramilitary
- Law Enforcement
- Fisheries & Conservation
- Coast Guard
- Search & Rescue
- Special Forces
- Anti-Piracy





# WORLDWIDE OPERATIONS & SUPPORT

MST is an international corporation with its headquarters in the United Kingdom. Through a network of both wholly owned companies and strategic partnerships we offer a truly global sales and support service established in over 21 countries around the world.

## COUNTRIES

- UK United Kingdom
- 1. Bangladesh
- 2. Brazil
- 3. China
- 4. Croatia
- 5. Cyprus
- 6. Dutch Antilles
- 7. France
- 8. Germany
- 9. Greece
- 10. India
- 11. Japan
- 12. Korea
- 13. Malaysia
- 14. Mexico
- 15. Netherlands
- 16. Norway
- 17. Oman
- 18. Portugal
- 19. Russia
- 20. Singapore
- 21. South Africa
- 22. Vietnam





“

***Established in over 21 countries  
around the world a truly global  
sales and support service***

---

# MST SPECIAL PRODUCTS



MST Special Products designs and develops special operations craft and unique products for the global defence, law enforcement and anti-terrorism markets.

Its range of submersible combat craft facilitate the covert delivery of personnel and are well proven with over 50 examples in service around the world.

MST Special Products also develops specialist ancillary products such as ballistic protection systems, covert self righting systems and other unique products for use both as standalone products and in conjunction with MST craft.

- **Submersible craft**
- **Unmanned surface craft**
- **Special operations craft**
- **Ballistic protection**

“

***MST Special Products Division provides submersible combat craft for the covert delivery of personnel***

---



# MST FLEET SERVICES



With focus on customer satisfaction MST can offer through life support packages and other after sales support options specifically tailored to suit the individual needs of our clients. Training is a natural part of our customer services and can provide users with training courses anywhere in the world.

You will find MST's after sales customer support outstanding. Our customised services will ensure that your investments are optimised throughout their life time.

- Technical Support
- Field Service Support
- Training
- Repair & Overhaul Services
- Periodic Maintenance
- Spare Parts Provisioning and Sales
- Configuration and Change Management
- Obsolescence Management
- Integrated logistic support
- Contract for availability

“

***You will find MST's after sales customer support outstanding***

---



# SPECIALISED INFLATABLE TECHNOLOGY



Specialised Inflatable Technology (SIT) is a world leader in the design and manufacture of low pressure inflatable products for marine, military, rescue, aviation and industrial markets around the world.

## MARINE

- RIB Sponsons
- Foam Fenders
- Self Righting Systems
- Inflatable and Solid Fenders
- Inflatable Boats
- White Water Rafts

## MILITARY

- Inflatable Workboats
- Inflatable Combat Craft
- Covert Self Righting Systems
- Bespoke Decontamination Units

## RESCUE

- Flood Rafts & Sleds
- Search & Rescue Boats, Paths, Sleds & Rafts,
- Vehicle Lifting Bags from 50kg – 10,000Kg
- Animal Rescue Systems

## AVIATION

- Aircraft Recovery Lifting Bags
- Inflatable Buildings
- Mass Evacuation Rafts

## INDUSTRIAL

- Door Seals
- Vessel Lining
- Support bladders
- Roof Jacks
- Truck assembly Air jacks
- CO2 Recovery Balloons
- Pipe stoppers



***Specialised Inflatable Technology (SIT) is a world leader in the design and manufacture of low pressure inflatable products***

---





A large, bright sun in a hazy sky, with a boat silhouette on the water below.

“

***MST is a customer focused  
organisation with a worldwide  
performance culture***

---



**Marine Specialised  
Technology  
Group Headquarters**

Unit 2 Atlantic Way  
Brunswick Business Park  
Liverpool  
Merseyside  
L3 4BE  
United Kingdom

Tel: +44 (0) 151 708 4112  
Fax: +44 (0) 151 708 4113  
Email: [sales@mstltd.com](mailto:sales@mstltd.com)

**[www.mstltd.com](http://www.mstltd.com)**

